

FEATURES

- 1/2 turn washerless ceramic disc valve cartridges
- Flexible hose connection for 24" spread installations
- 3/4" valve with flow rate of 10 gpm (37.85 lpm) maximum flow rate
- Solid brass construction
- Warranty:
 - Limited lifetime warranty (residential use)
 - One year (commercial use)
- Standard finishes:
 - polished chrome
 - satin nickel
 - polished nickel
 - rustic brass
- Listed by IAPMO, CSA, NSF, and other municipalities
- Shipping weight (lbs.) 10
- Shipping dimensions (in.): 22x12x4

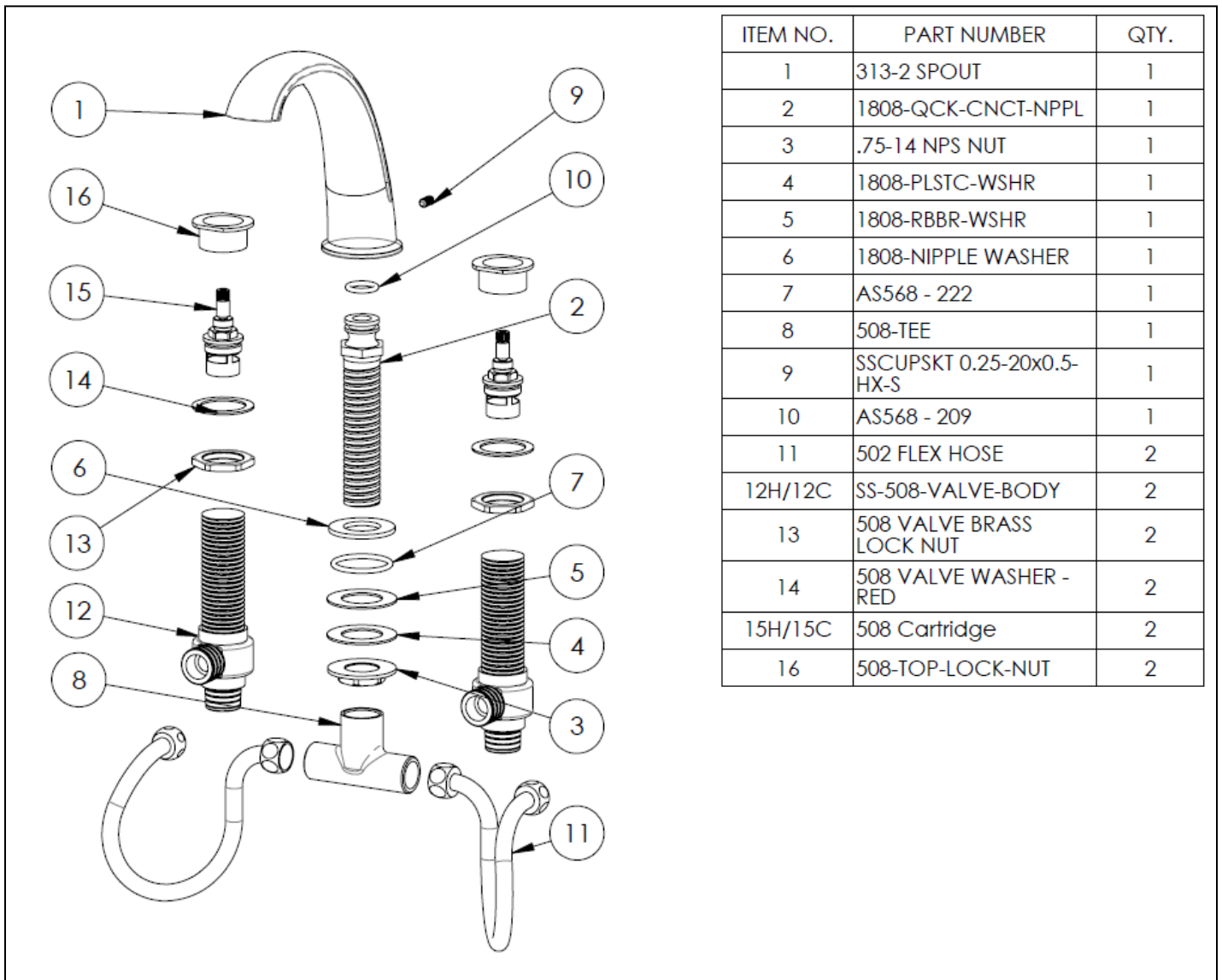

ITEM NO.	PART NUMBER	QTY.
1	313-2 SPOUT	1
2	1808-QCK-CNCT-NPPL	1
3	.75-14 NPS NUT	1
4	1808-PLSTC-WSHR	1
5	1808-RBBR-WSHR	1
6	1808-NIPPLE WASHER	1
7	AS568 - 222	1
8	508-TEE	1
9	SSCUPSKT 0.25-20x0.5-HX-S	1
10	AS568 - 209	1
11	502 FLEX HOSE	2
12H/12C	SS-508-VALVE-BODY	2
13	508 VALVE BRASS LOCK NUT	2
14	508 VALVE WASHER - RED	2
15H/15C	508 Cartridge	2
16	508-TOP-LOCK-NUT	2

1. **Carefully remove all parts from the box.**
2. **Begin by first installing the Spout.**
 - a. Remove the "T" Assembly (8) and spout lock nut (3) from the Spout (1).
 - b. Drop the Spout through the hole in your countertop or sink.
 - c. Tighten the Lock Nut (3) against the underside of mounting surface .
 - d. Re-assemble "T" Assembly onto bottom of Spout.
3. **Identify your Hot and Cold Valves.**
 - a. Remove all trim from Valve Assembly (including Top Lock Nut [16] where applicable), leaving Bottom Lock Nut (13).
 - b. Begin to tighten the Valve to your countertop or sink with a Top Lock Nut (16) (Refer to Diagram) but do not tighten completely.
 - c. Install Escutcheon and Handle (refer to "Handle Trims" section) on valve body (12). Be sure that bottom of handle properly clears top of the Escutcheon.
 - d. Once you have adjusted the Valve height, remove Handle and proceed to tighten Valve from the bottom until it is snug.
 - e. Install Handle on the Valve.
4. **Connect the two Flex Hoses (11) to "T" Assembly (8) and to the HOT (12H) and COLD (12C) valves respectively.**
These hoses can be bent or twisted, but be careful not to kink the hoses or you will have limited water supply and excessive noise from the faucet.
5. **Begin by bleeding the water lines before connecting to the valves. Connect water supplies to bottom of each valve.**
6. **Flush faucet by running both Hot and Cold water in full open position.**
7. **Check for leaks. If leaks or problems occur, re-tighten all nuts before consulting a plumber.**

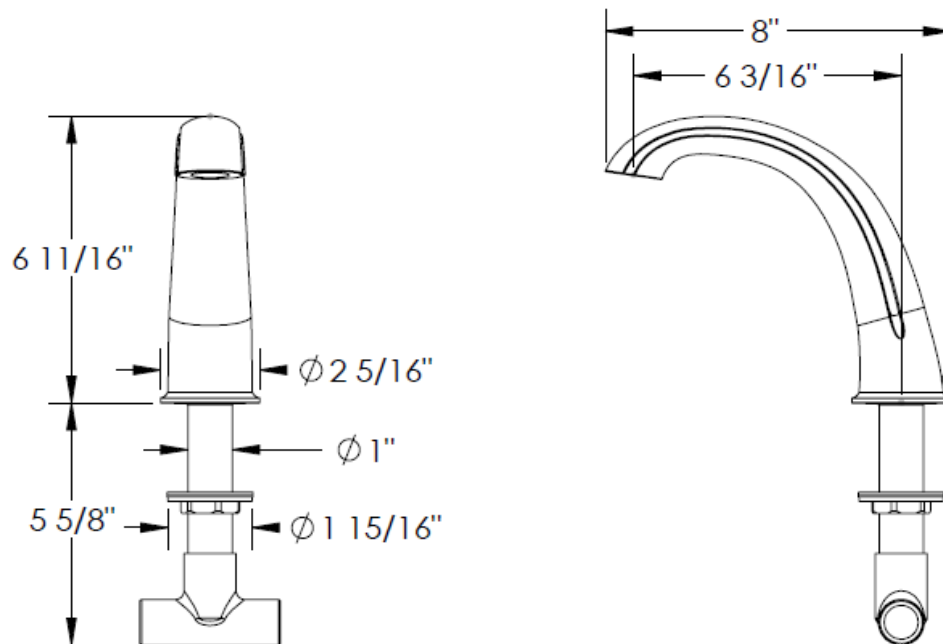

HANDLE TRIMS

New York (Code: A)

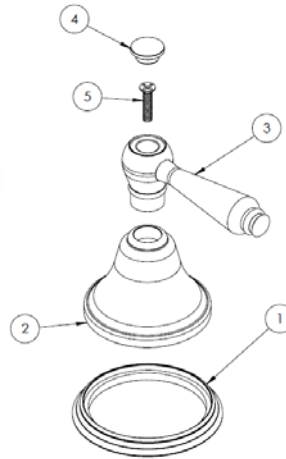

ITEM NO.	PART NUMBER	QTY.
1	A-ESC-RING	1
2	A-ESC	1
3	A-LVR	1
4	A-POST-CAP	1
5	CR-FHMS 0.164-32x0.75x0.75-S	1

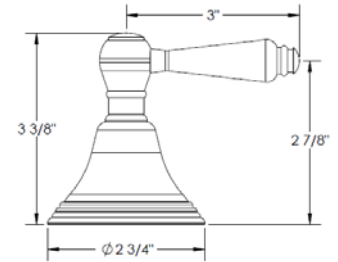

Charlton (Code: AXP)

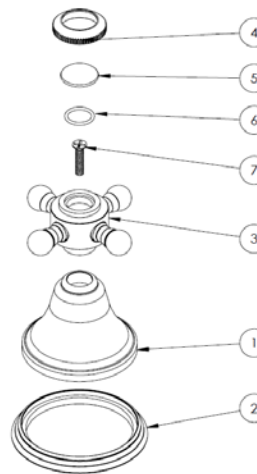

ITEM NO.	PART NUMBER	QTY.
1	A-ESC	1
2	A-ESC-RING	1
3	X-POST	1
4	X-CAP-RING	1
5	X-PRCLN-INSRT-(PLN/COLD/HOT)	1
6	AS568 - 014	1
7	CR-FHMS 0.164-32x0.75x0.75-S	1

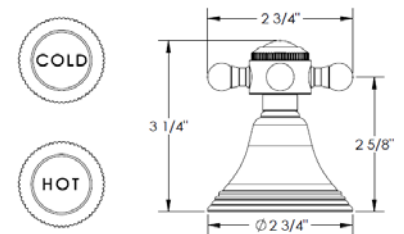

Houston (Code: F)

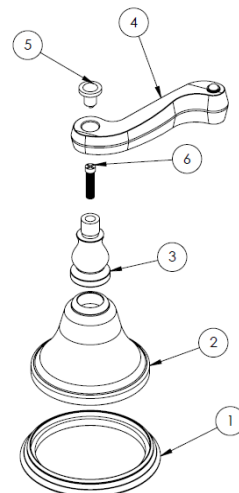

ITEM NO.	PART NUMBER	QTY.
1	A-ESC-RING	1
2	A-ESC	1
3	F-POST	1
4	F-LVR	1
5	F-POST-CAP	1
6	F-POST-SCRW	1

HNDL: 3, 4, 5 & 6

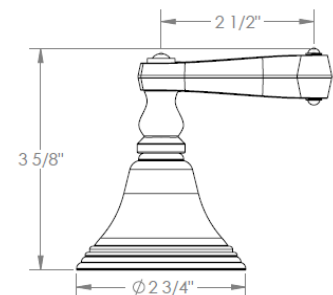

Williams (Code: Y2)

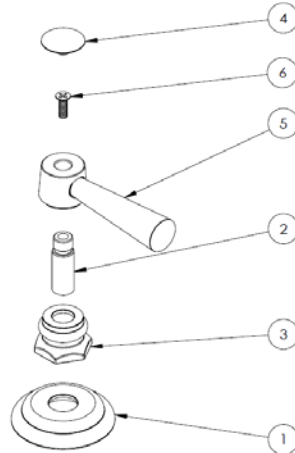

ITEM NO.	PART NUMBER	QTY.
1	S1-ESC	1
2	S1-STEM	1
3	S1-ESC-NUT	1
4	SA1-POST-CAP	1
5	SA1-LVR	1
6	CR-FHM1 0.164-32x0.5x0.5-S	1

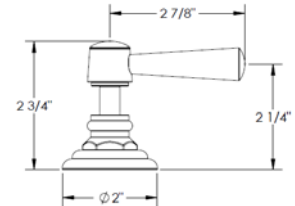

For technical support, please call 718-257-2800

IMPORTANT INSTALLATION INFORMATION

- USE TEFLON TAPE OR PIPE SEALANT FOR THREADED CONNECTIONS
- DO NOT USE PLUMBER'S PUTTY ON ANY OF THE BRASS COMPONENTS
This will cause the finish to tarnish and void the warranty. A non-corrosive Silicone is recommended.
- DURING SWEATING OF LINES DO NOT OVERHEAT CASTING
Overheating may cause damage to internal mechanism
- COPPER ADAPTORS MAY BE REQUIRED TO COMPLETE YOUR INSTALLATION

Rev. 1/1